



# Renold Chain Products

**RENOLD**  
*Superior Chain Technology*

know-how makes the difference

**ERIKS**

# INTRODUCTION



## Leading edge technology

**Renold provides practical, cost effective solutions with a commitment of value through quality by continuous investment in people, process technology and manufacturing.**

### **Consistant Reliability**

Renold has more than 125 years of experience in the design and manufacture of power transmission products to the highest specification. Our proven performance across diverse industries worldwide gives our customers confidence in guaranteed quality and the assurance of reliability in Renold products.

### **Special Solutions and Innovations**

Renold is recognised throughout the industry for its ability to create bespoke solutions to customers' unique requirements. A wide range of industries - from steel works to food processing plants, escalator manufacturers and textile machinery installers - have chosen Renold to solve their power transmission problems.



## Local and International Availability

The Renold organisation stretches worldwide:

- More than 20 National Sales Companies
- Almost 100 Overseas distributors offering the comprehensive Renold range of power transmission products, directly or through local ERKS Service Centres.

## Approvals and Quality Assurance

- Renold manufacturing sites are certified to ISO 9001:2000. Our roller chain manufacturing sites are certified to ISO 14001:2004.
- We are also able to manufacture to the specifications required by API and BAE

## Renold Chain Selector

The Chain Selector from Renold makes it even easier to specify the right transmission chain for the job.

You can quickly and easily generate a selection, alter parameters to include environmental factors like corrosion or lubrication and even allow for applications with shock loads.

[www.renoldchainselector.com](http://www.renoldchainselector.com)





## Simply the best

**Synergy is the only true high-performance chain on the market. Engineers and maintenance professionals around the world endorse the wear resistance and exceptional working life of this remarkable chain technology.**

### Consistent Reliability

New specially formulated lubricant has improved initial wear life by up to 50%.

Available in British Standard sizes ranging from 06B to 24B in simplex, duplex and triplex construction.

Available in ANSI Standard sizes ranging from 35 to 160 in simplex, duplex and triplex construction.

Make your business more efficient. Contact your local ERIKS Service Centre to put Renold Synergy to work for you today.

### Features & Benefits

- Improved fatigue resistance
- Better wear resistance
- Built to perform

### Built to be better

- Synergy® lasts longer and resists greater shock loads, making it the most reliable chain on the market.
- Unique end-softened pins
- Our platinum-coloured connecting links stand out against the black surface plates, so they're easy to identify and remove.

### Applications

Renold Synergy® has transformed the productivity and efficiency of all these industrial applications and more.

- Pharmaceutical
- Iron & Steel
- Tyre Manufacture
- Bakery
- Furnace Conveyor
- Bottling
- Fruit Washing
- Packaging
- Confectionary
- Timber Processing

### Trouble Shooting - Fatigue Failure

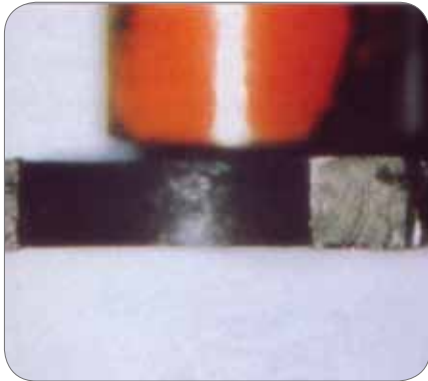

Application	Transmission chain was used in a highly impulsive load application.
Failure Mode	Inner plate suffered a fatigue failure
Diagnosis	Due to the high impulsive loading, a crack started at the edge of the plate hole and crack propagation occurred, resulting in a 'classic' fatigue failure.
Solution	Eliminate high impulsive loading or select larger pitch chain.



Renold Synergy is the only high performance transmission chain on the market

- Unbeatable wear and fatigue resistance
- Withstands shock loadings better than any other standard chain
- Reduced initial wear
- Productivity improves with Renold Synergy

### Trouble Shooting - Wear Failure



Application	1.5" P BS duplex chain
Failure Mode	Pin bearing areas worn. Note position of intermediate plates is clearly visible.
Diagnosis	Over a long period of time the pins have gradually worn until the chain elongation has reached 2%
Solution	Monitor chain extension regularly

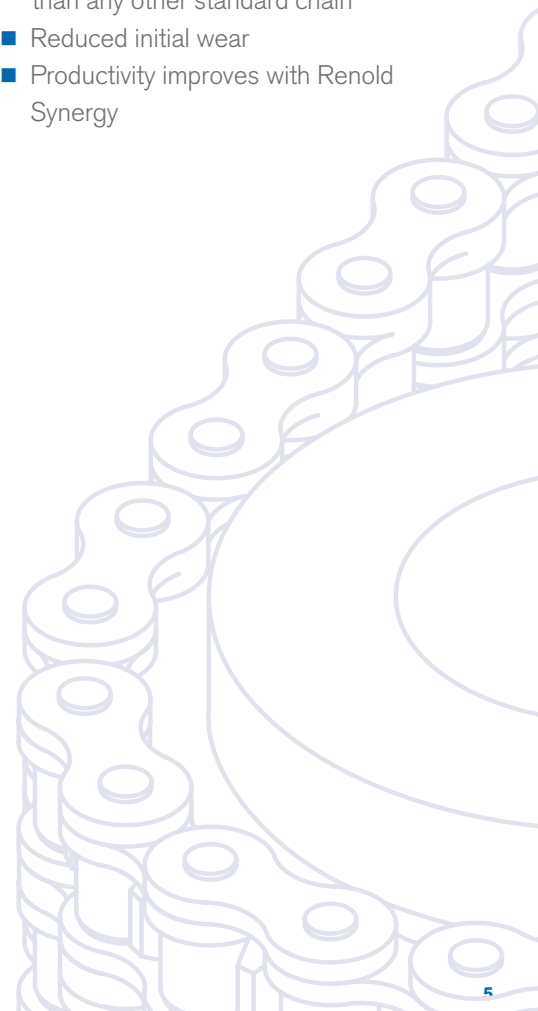



# RENOLD SYNO™ CHAIN



## Three solutions, one aim. No more lube!

**If it's an easy life you want, if lubrication causes you problems, then Renold has the answer! The Renold Syno range sets a new benchmark for chain performance with little or no lubrication. Covering both small and large pitch sizes, Renold has tailored its technology to suit your requirements with a range of three different products under the Renold Syno name.**

### **Nickel-plated**

For use in hygiene-sensitive applications or situations where contamination from lubricant is to be avoided, Renold Syno Nickel Plated chain displays all the characteristics you need from a chain.

With a food industry-approved lubricant within the sintered bush, this chain will in almost all instances not need relubricating. The roller coating is also suitable for use in the food industry; a unique feature on any chain.

Available in boxed 10-foot lengths from 06B to 24B and ANSI 40 to ANSI 100, simplex and duplex with a standard pin diameter, this means that Renold Syno Nickel Plated chain is dimensionally interchangeable with standard roller chain and is even compatible with standard sprockets.

- No lubrication normally required
- Outside of chain totally dry-to-the-touch
- Nickel-plated plates
- Food industry-approved lubricant within the sintered bush
- Unique food industry-approved roller coating
- Dimensionally interchangeable with standard chain
- ISO standard pin diameter, therefore standard attachments on outer links

### **Applications**

- Food
- Pharmaceutical
- Bottling
- Textile
- Packaging

### Trouble Shooting - Fretting Corrosion



Application	Transmission chain with pushers at intervals to control the conveying of boxes of breakfast cereal.
Failure Mode	Severe wear of one pin of the pusher attachment and red deposit indicating fretting corrosion.
Diagnosis	The pusher attachment was designed 50.8mm pitch to fit on a chain of 25.4mm pitch and operate on sprockets designed for 25.4mm pitch chains. This caused very high pressure on one pin of the attachment link which squeezed out most of the lubricant. This resulted in the marginal lubrication situation required to produce fretting corrosion.
Solution	<ol style="list-style-type: none"> <li>1. Use specially designed sprocket teeth with relieved tooth pocket at the attachment position.</li> <li>2. Employ a high performance lubricant with solid residue to prevent squeeze-out.</li> </ol>



Syno PC Chain



Polymer Bush



Nickel-plated

### Trouble Shooting - Corrosion



Application	Chain drive used on a barrelling machine.
Failure Mode	Corrosion.
Diagnosis	This chain has been used in an environment with water contamination. The chain has not been regularly lubricated and external parts have gradually corroded until the rollers seized. The chain has then proceeded to wear heavily on the rollers.
Solution	Protect from water if possible. Increase degree of maintenance lubrication.

# RENOLD CORROSION RESISTANT CHAIN



## Hydro-Service

**Renold Hydro-Service chain delivers superior corrosion resistance, lasting as much as 30 times longer than standard carbon steel in applications that have to deal with water or salt spray. It is ideal for wash-down environments. Hydro-Service chain is also more economical, and stronger, than stainless steel.**

Each component is mechanically treated prior to assembly to ensure consistent, secure protection. The surface treatment is free of hexavalent chrome, complying with legislation relating to environmental and health & safety considerations.

- Superior corrosion resistance
- Last as much as 30 times longer than standard carbon steel
- Hexavalent chrome free
- 350 hours corrosion protection during salt spray tests to DIN 50021
- Cold extruded, solid bush and roller delivering maximum Renold

performance

- Plates and rollers shot peened to our exact specifications
- Wear and fatigue resistance that delivers maximum working life
- Lubrication that improves wear performance

### Applications

- Water treatment plants
- Marine / offshore
- Cold Stores
- Wash down

### Trouble Shooting - Corrosion



Application	
<b>1.75" ANSI simple detachable chain used on a table roll drive in a steel mill.</b>	
Failure Mode	Heavy corrosion and erosion of all parts.
Diagnosis	Bush and rollers have corroded / worn to a wafer thin condition with corresponding wear on the pins. Plates have a great deal of side wear and are heavily pitted. This chain has been used in an extremely hostile environment subject to high temperatures and water spray.
Solution	Improve lubrication methods. Consider using a corrosion resistant chain.



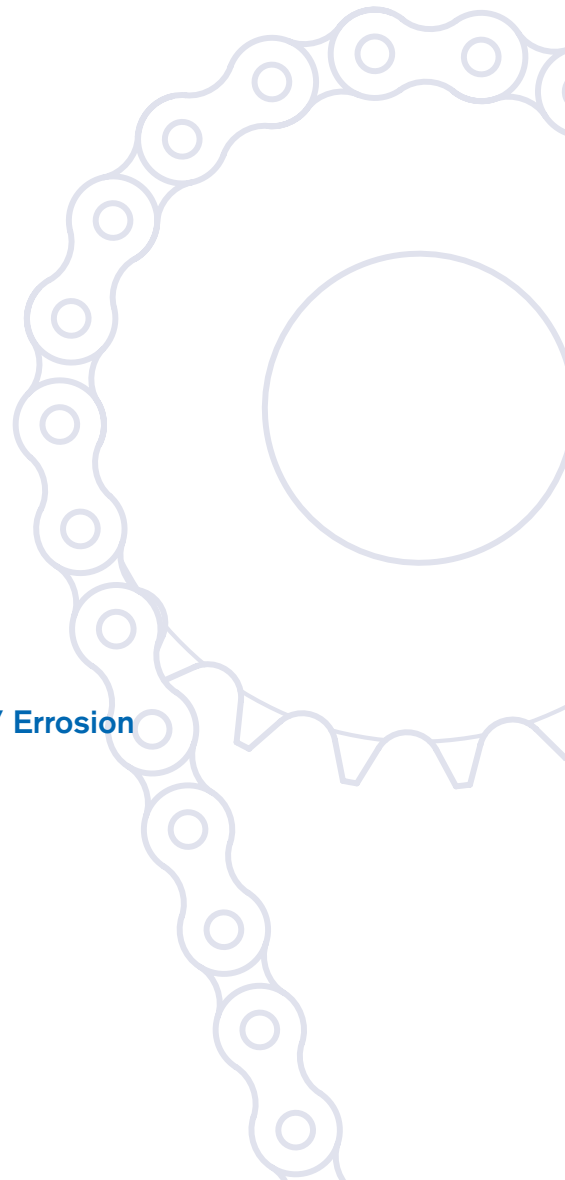

## Stainless Steel Chain

Renold Stainless Steel chain is made from high grades of austenitic rust-proof steel. These perform extremely well in environments that are acidic, alkaline, where direct contact with food is a consideration, where the chain will be exposed to water, and for very high or very low temperature locations ( -40° to +400°C ) where resistance to corrosion is a requirement.

Renold Stainless Steel chain should be selected when resistance to chemical action is critical. It is manufactured using FDA approved material and is prelubricated with USDA H1 approved lubricant.

- All components made from austenitic rust-proof steel
- All components receive surface finishing to remove stress raisers
- Lubrication that improves wear performance
- Tensile strength is approx. 65% that of standard carbon steel chain.

### Trouble Shooting - Corrosion / Errosion



Application	1.75" ANSi duplex chain used on a carrier drive in a sugar mill.
Failure Mode	Heavy corrosion of all the components in the chain.
Diagnosis	The chain had been operating without any lubricant being applied and was also subject to attack by acidic sugar juice. As a result the chain suffered heavy corrosion and wear.
Solution	Replace the chain and ensure adequate lubrication is applied. Protect the chain from juice with an appropriate casing.



## The benchmark for abrasion resistance

Abrasive environments such as brick and tile manufacture, which are characterised by dust and debris, are perfect examples of applications that demand the inclusion of Renold Sovereign chain. The design of Renold Sovereign ensures greatly increased wear resistance. The chain is able to withstand the effect of dust and debris infiltrating the bearing areas between pins, bushes and plates, an effect that would quickly grind away a standard chain.

### Features & Benefits

- Resilient, durable components
- Up to 3 times longer wear life than standard chain in harsh environments
- Up to 4 times longer wear life than low maintenance chain in harsh environments
- Reduced pin wear
- Suitable for high speed or heavy load applications
- Excellent reliability giving reduced maintenance costs
- Ideal for situations of irregular or restricted maintenance

### Applications

- Agricultural machinery
- Brick manufacture
- Ceramics
- Cementitious environments
- Metal working
- Roof tile production
- Timber processing

### Trouble Shooting - Abrasion



Application	Chain used in handling wet china clay.
Failure Mode	Severe wear between the chain bush and roller in a china clay extraction plant.
Diagnosis	Abrasive residues (Quartz) in the clay from the original granite material causing wear to the surfaces.
Solution	Specify Renold Chain with extra hard surface materials to be included in the manufacture of chain round parts.

# STANDARD CONVEYOR CHAIN



## Standard Conveyor Chain

Renold has established an unrivalled track record in the design and manufacture of Conveyor Chain. The unique properties of Renold's product, its standards and specifications, ensure long lasting performance in demanding applications and environments. We offer complete solutions and total capability in all sectors.

### Specifying Renold gives you peace of mind

- The performance of Renold Conveyor Chain is ensured by a programme of continuous testing and quality control
- Specially formulated lubricants reduce initial wear and provide corrosion protection
- Breaking loads exceed the minimum international standards
- Renold's experienced sales, production and design staff are always available to freely advise on particular products and applications
- Flexibility, Service Excellence and Care
- Cost Effective Innovative Complete Solutions
- Leading Edge Technology
- Enhanced Performance and Improved Life Expectancy
- Ultimate Consistency, Reliability and Capability





# ADAPTED CONVEYOR CHAIN



## Customised engineering chain

Covering a wide range of products to suit specialised applications these solutions often using a mix of high specification materials and treatment processes to meet the demands of the particular application.

## Steel knuckle chain

A USA-designed range of heavy duty, robust, detachable elevator bush chains fitted with integral K type attachments.

## Agricultural roller chain

Produced to ISO/DIN standard and also a range of Works Standard chains used mainly on agricultural harvesting equipment.

### Attachments

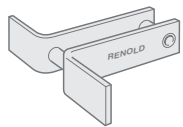

L0 - Integral

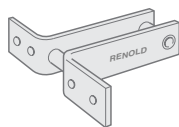

L2 - Integral

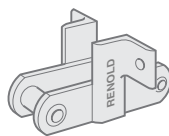

F1 - Welded

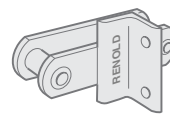

F2 - Welded

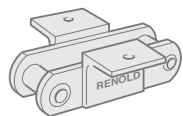

K1 - Welded

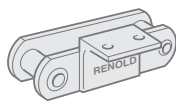

K2 - Welded

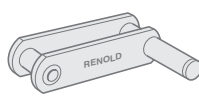

L0 - Integral

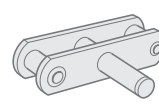

L2 - Integral

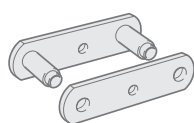

F1 - Welded

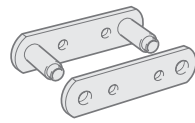

F2 - Welded

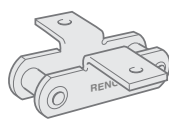

K1 - Welded

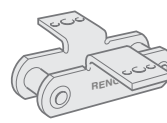

K2 - Welded

### Applications:

- Paving & Construction
- Food Mills
- Vehicle Assembly
- Sterilizing plants
- Water & waste water plants
- Kiln Conveyors
- Everyday use



# ADAPTED ROLLER CHAIN



## Attachment chain

The most comprehensive range available

- Many attachments available from stock
- Dedicated production facilities to meet customer demands
- Extensive experience and flexibility



## Renold Klik-Top™

Klik-Top™ polymer block chain is quick to install, strong, suitable for use in hygiene-sensitive areas if required and will cut costly downtime experienced when using conventional polymer block chain.

Klik-Top™ chain ensures reliability, quality and great value for money. Ideal for conveying delicate items such as glass, wood and packaging. You can have confidence in Klik-Top™ chain.



- Short downtimes - increased productivity
- Durable polymer clip
- Easily replaced in moments
- Food industry approved
- Other base chains available (ask for details)
  - Stainless steel
  - Syno lube free

**Standard Attachment Chain ready in 72 hours... or faster!**



- Get your quote over the phone
- Orders ready for despatch within 72 hours
- 48 hour or 24 hour service also possible
- European (BS) transmission chain 08B to 16B
- ISO standard K or M attachments or extended pins



# RENOLD ACCESSORIES



## Renold ROLL RING®

Roll-Ring is an innovative chain tensioner made from a specially formulated polymer. The unique design is based upon a toothed ring that can be fitted to horizontal, vertical or diagonal drives in a matter of seconds, simply by placing it in-between the two strands of chain.

When the drive is in use, the Roll-Ring deforms to an elliptical shape, due to the compression between the strands and completely absorbs any slack in the system. Roll-Ring performs the job of a tensioner and a damper in one, and is ideally suited to applications where maintenance is difficult or impossible.

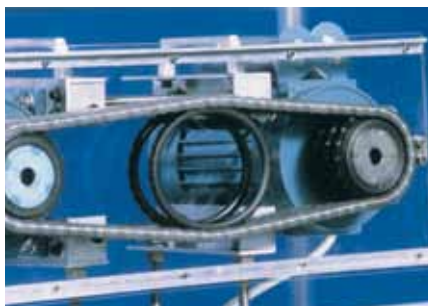

**The ROLL RING® chain tensioner tensions and dampens**

## Chain Pin Extractor

Do you have to grind chain to cut it? Renold makes cutting chain easy. Using the Renold Chain Pin Extractor cutting chain is effortless, it takes just seconds and there's no mess.

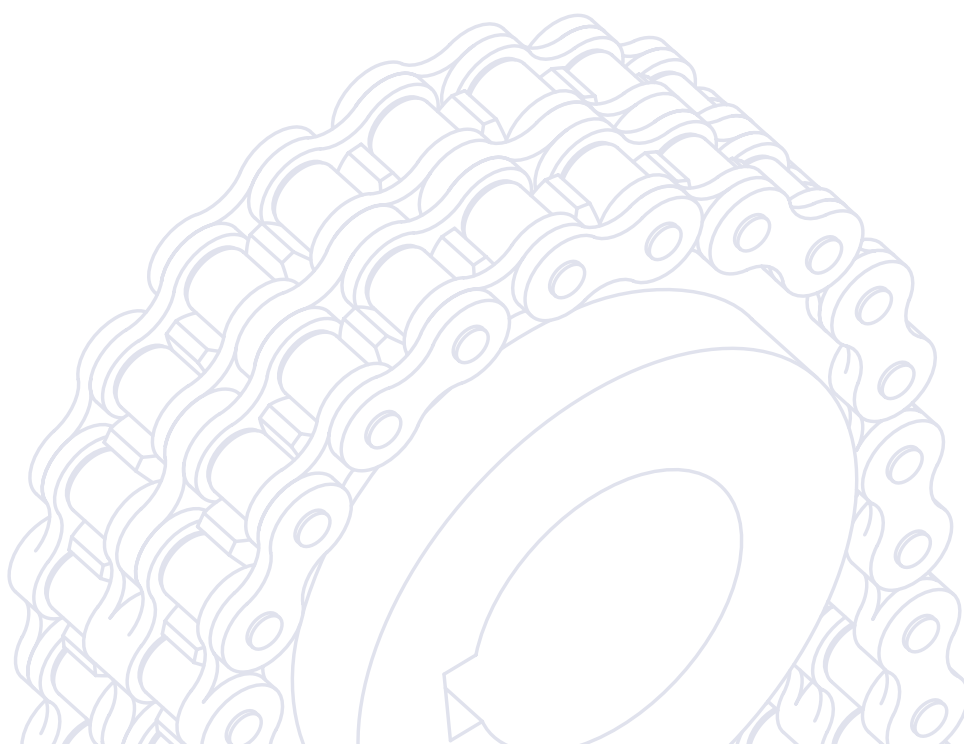

**Trouble shooting - Sprocket Tooth Wear**



**Sprockets**

Renold offer a comprehensive range of stock transmission chain sprockets for British Standard chain up to two inch pitch. Other sizes of sprocket, including those to American Standard dimensions, are available on request.

Special sprockets are also manufactured on request, in special materials or formats, normally to suit a specific application in harsh or difficult drive situations.

For a copy of the complete Troubleshooters Guide or for more information on the Power Transmission services from ERIKS, please contact your local branch.

0845 006 6000  
[www.eriks.co.uk/Locations/](http://www.eriks.co.uk/Locations/)

Application	Sprockets fitted at the end of a conveyor.
Failure Mode	Severe hooking wear of the sprocket teeth has been compounded with a second phase of hooked wear.
Diagnosis	The original chain and sprockets have followed normal wear patterns with hooked wear of the sprocket teeth and pitch elongation of the chain. A new chain has then been fitted to the old wheels which have a worn tooth form incompatible with the pitch of the new chain. The result is severe secondary wear of the sprocket teeth and probably very rapid chain pitch extension.
Solution	Always check the condition of the existing sprocket teeth before fitting a new chain to any system. In this case the sprockets must be renewed and the chain checked for damage.

**Trouble Shooting - Lubrication & Alignment**



Application	1" P BS duplex chain driving a flywheel on a 400 Tonne press.
Failure Mode	Excessive wear. Chain jumping teeth causing tooth rounding.
Diagnosis	Examination of the chain showed no lubrication had been applied in the 6 months service life. The loads involved require a minimum of oil sump lubrication. In addition to this the centre distance was higher than recommended and the sprockets were out of line.
Solution	Improve the lubrication method. Consider hardening the driver teeth. Correct the drive alignment.



EB137/1114 © ERIKS Industrial Services, all rights reserved.

Call 0845 006 6000  
[www.eriks.co.uk](http://www.eriks.co.uk)

**ERIKS UK**

Amber Way, Halesowen,  
West Midlands, B62 8WG



**ERIKS**